

Top Only - Runner Spacing is the same as TH115:
The SH96 will stack Centered Lt to Rt
with both cabinet fronts flush with each other.

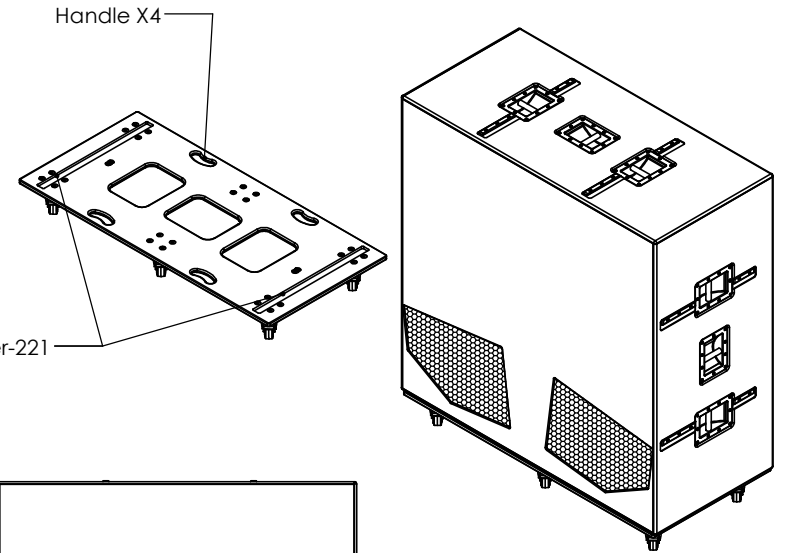

1/2" Deep Recess
for Bottom Skid Runners.
Compatible with Cinemonster-221

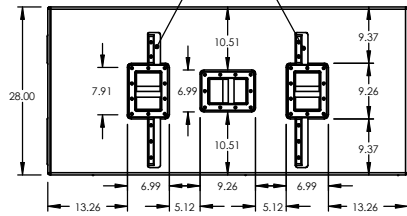
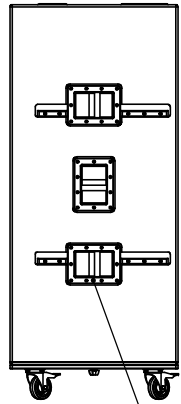

Steel Handle
12 Places

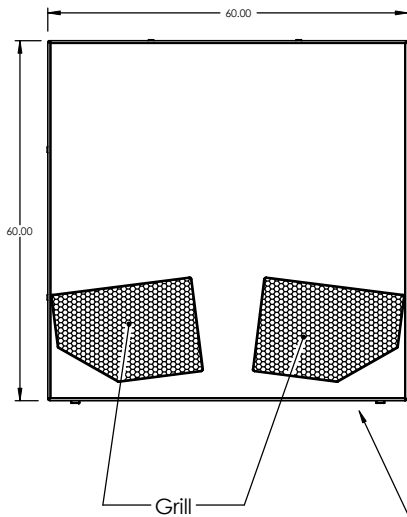

Grill

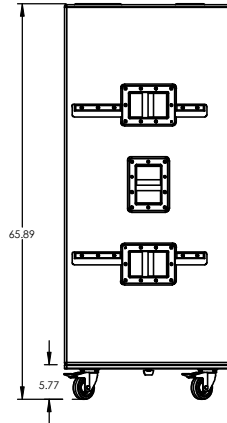

Caster Board Hidden
for Clarity

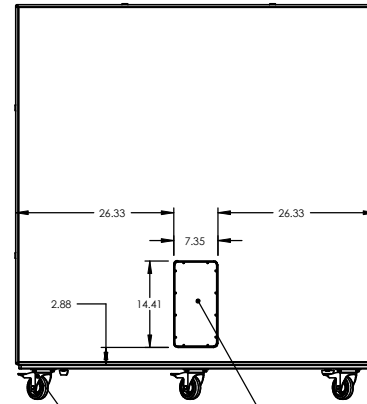

NL4 X2

Optional Caster Board:
4" Dia. Casters - 6 Places

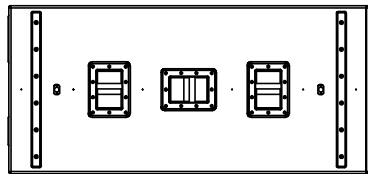

PROPRIETARY AND CONFIDENTIAL
THE INFORMATION CONTAINED IN THIS
DRAWING IS THE SOLE PROPERTY OF
QUALITY MUSICAL SYSTEMS, INC. ANY
REPRODUCTION IN PART OR AS A WHOLE
WITHOUT THE WRITTEN PERMISSION OF
QUALITY MUSICAL SYSTEMS, INC. IS
PROHIBITED.

MATERIAL
FINISH
DO NOT SCALE DRAWING

UNLESS OTHERWISE SPECIFIED:
DIMENSIONS ARE IN INCHES
TOLERANCES:
FRACTIONAL ±
ANGULAR: MACH ± BEND ±
TWO PLACE DECIMAL ±
THREE PLACE DECIMAL ±

DRAWN TBW 7/20/2009
ENG APPR.
MFG APPR.
Q.A.

Danley Sound Labs

TITLE: TH812 (Rockmonster)

SIZE A TH812 Plan View Drawing

SCALE: 1:32 Last Save Date: Monday, July 20, 2009 1:15:19 PM



REV x3