

## INSTALLATION GUIDE / USER MANUAL

DSA500X4 • DSA750X4

Rev. 20220706

# Technical and Safety Notices

Please read the following important technical, safety and environmental notices before installing and using your amplifier.

## Technical Notices

All reasonable design and engineering steps have been taken to ensure that these amplifiers always perform satisfactorily in their intended application and environment and will provide appropriate levels of support to ensure that all reasonable customer needs and expectations are met. Such support however is contingent on the following provisions.

1. These amplifiers are Class-I products and should be installed with a mains cable including the required earth connection to comply with the Safety Class-I.
2. These amplifiers should always be installed by competent and qualified personnel. Amplifier damage or failure caused by installation or operational errors may invalidate support, warranty or guarantees of performance.
3. These amplifiers are not suitable for use in locations where they may be accessible to minors.
4. These amplifiers are intended to be used specifically for the amplification of audio signals and for connection to moving-coil loudspeaker systems. Use of these amplifiers for amplification of signals outside the audio band (20Hz to 20kHz) or to drive transducers other than moving-coil loudspeakers may invalidate support, warranty or guarantees of performance.
5. These amplifiers should only be used within professionally installed and configured audio systems comprising input and output ancillary equipments that is known to be of an appropriate level of performance and in good operating condition. Any damage to, or unsatisfactory performance from, these amplifiers caused by inadequate or failed input or output ancillaries may invalidate support, warranty or guarantees of performance.
6. These amplifiers are intended to be installed and operated indoor in a controlled environment (pollution degree, PD2) within an ambient temperature range of 0°C to 40°C. These amplifiers are not intended for use above 2000 meters above sea level. Amplifiers installed or operated in environments outside these limits may invalidate support, warranty or guarantees of performance.
7. Specific warranty terms are the responsibility of the amplifier re-seller.

## Safety and Environmental Notices

*Note: The intent of the lightning flash with arrowhead symbol in a triangle is to alert the user to the presence of uninsulated "dangerous" voltage within the product's enclosure that may be of sufficient magnitude to constitute a risk of electric shock to humans.*

*Note: The intent of the exclamation point within an equilateral triangle is to alert the user to the presence of important safety, and operating and maintenance instructions in this manual.*

**WARNING! TO PREVENT FIRE OR ELECTRIC SHOCK, DO NOT EXPOSE THIS EQUIPMENT TO RAIN OR MOISTURE.**

**Ambient Temperature Note: If this equipment is operated in a confined or multiple rack installation, the internal ambient operating temperature may exceed the external ambient temperature.**



**It is important to ensure in these circumstances that the published maximum operating temperature for the equipment is not exceeded.**



**Reduced Air Flow: Ensure that rack or other closed installation does not restrict the cooling airflow required for safe and reliable operation of the equipment.**

# Technical and Safety Notices

## Important Safety Instructions

1. Read these instructions.
2. Keep these instructions.
3. Heed all warnings.
4. Follow all instructions.
5. Do not use this apparatus near water.
6. Do not submerge the equipment in water or liquids.
7. Do not use any aerosol spray, cleaner, disinfectant or fumigant on, near or into the equipment.
8. Clean only with a dry cloth.
9. Do not block any ventilation opening. Install in accordance with the manufacturer's instructions.
10. Do not install near any heat sources such as radiators, heat registers, stoves, or other apparatus (including amplifiers) that produce heat.
11. To reduce the risk of electrical shock, the power cord shall be connected to a mains socket outlet with a protective earthing connection.
12. Do not defeat the safety purpose of the polarized or grounding type plug. A polarized plug has two blades with one wider than the other. A grounding type plug has two blades and a third grounding prong. The wide blade or the third prong are provided for your safety. If the provided plug does not fit into your outlet, consult an electrician for replacement of the obsolete outlet.
13. Protect the power cord from being walked on or pinched particularly at plugs, convenience receptacles, and the point where they exit from the apparatus.
14. Do not unplug the unit by pulling on the cord, use the plug.
15. Only use attachments/accessories specified by the manufacturer.
16. Unplug this apparatus during lightning storms or when unused for long periods of time.
17. Refer all servicing to qualified service personnel. Servicing is required when the apparatus has been damaged in any way, such as power supply cord or plug is damaged, liquid has been spilled or objects have fallen into the apparatus, the apparatus has been exposed to rain or moisture, does not operate normally, or has been dropped.
18. The appliance coupler, or the AC Mains plug, is the AC mains disconnect device and shall remain readily accessible after installation.
19. Adhere to all applicable, local codes.
20. Consult a licensed, professional engineer when any doubt or questions arise regarding a physical equipment installation.

## Environmental Statement



This product complies with international directives, including but not limited to the Restriction of Hazardous Substances (RoHS) in electrical and electronic equipment, the Registration, Evaluation, Authorization and restriction of Chemicals (REACH) and the disposal of Waste Electrical and Electronic Equipment (WEEE). Consult your local waste disposal authority for guidance on how properly to recycle or dispose of this product.

# Introduction and Overview

## 1. Introduction

Danley DSA power amplifiers have been designed to provide configurable, consistent and reliable high performance audio power amplification for residential, commercial and entertainment applications.

This manual covers the features, installation and functions of the Danley DSA500X4 and DSA750X4 models. Please read the manual fully before installing and using an amplifier. If you have any questions regarding amplifier configuration, installation or operation please contact the appropriate customer support portal.

Following this introduction, the manual is divided into sections covering the following topics:

- 2. Overview
- 3. Carton Contents
- 4. Installation
- 5. Configuration
- 6. Connections
- 7. Operation
- 8. Specifications

## 2. Amplifier Overview

Danley DSA500X4 and DSA750X4 amplifiers are a full rack width, 2U format power amplifiers that can drive both conventional low impedance (Lo-Z, 4Ω to 16Ω) loudspeakers and high impedance (Hi-Z, 70V/100V) transformer coupled loudspeakers. They provide four analog inputs, one stereo S/PDIF digital input, and either two or four outputs (Lo-Z mode), or one or two outputs (Hi-Z or Lo-Z BTL mode). Danley DSA amplifier model output channel counts and power outputs are as follows:

### Danley DSA500X4

Mode	Channels	Max Rated Output per Channel
Lo-Z	Four	500 Watts
Lo-Z (BTL)	Two	1000 Watts
Hi-Z	Two	1000 Watts

### Danley DSA750X4

Mode	Channels	Max Rated Output per Channel
Lo-Z	Four	750 Watts
Lo-Z (BTL)	Two	1500 Watts
Hi-Z	Two	1500 Watts

*Note: In Lo-Z BTL (bridge-tied load) mode, two amplifier output channels are combined to create a single, double power output channel. BTL mode can be engaged via the amplifier Output Mode configuration setup menu described in Section 5 of this manual.*

# Introduction and Overview

## 2.1 Connections and Power Switching

Danley DSA signal input and output connections are accomplished via RCA Phono and Euroblock style connectors. A GPIO (General Purpose In/Out) Euroblock connector enables some amplifier functions to be controlled externally, and wireless or RJ45 socket Ethernet network connection options are also provided. Cable connectors and connections are described and illustrated in **Section 6** of this manual

Danley DSA amplifiers incorporate a front panel mounted power button. Press the button once to switch the amplifier on or off. Amplifier power management behaviour can be configured via the Control web app **Settings Menu** described in **Section 5** of this manual.

## 2.2 Network Features

Danley DSA amplifiers are TCP/IP network connected devices that require a wired or wireless network connection to access their configuration menus. The configuration menus are accessed via the Control Web App interface and cover Input, Zone, Output and General Settings functions. The Control web app configuration menus are described in **Section 5** of this manual.

## 2.3 Firmware

This manual describes the features, functions and user interface of Danley DSA amplifiers running **Firmware Version 1.2.0**.



**It is strongly recommended that the firmware version installed in the amplifier in use is checked initially, and regularly thereafter. If updated firmware is available, the amplifier should be updated as a priority.**

The firmware installed in the amplifier can be identified and updated by selecting the **Device** option in the Control web app **Settings Menu**. Firmware versions can be checked, and firmware downloaded, from the website: <https://www.danleysoundlabs.com>

## 3. Carton Contents

Danley DSA amplifiers are shipped in a cardboard carton containing the amplifier unit, a mains cable appropriate for the sales territory, an accessory pack, and a document pack. The full contents is listed below.

- Amplifier unit
- Rack mount ears (fitted)
- Mains power cable
- Input connector x 2
- GPIO socket connector
- Output connector x 1 or 2
- Adhesive rubber feet x 4
- Document pack

# Installation

## 4. Installation

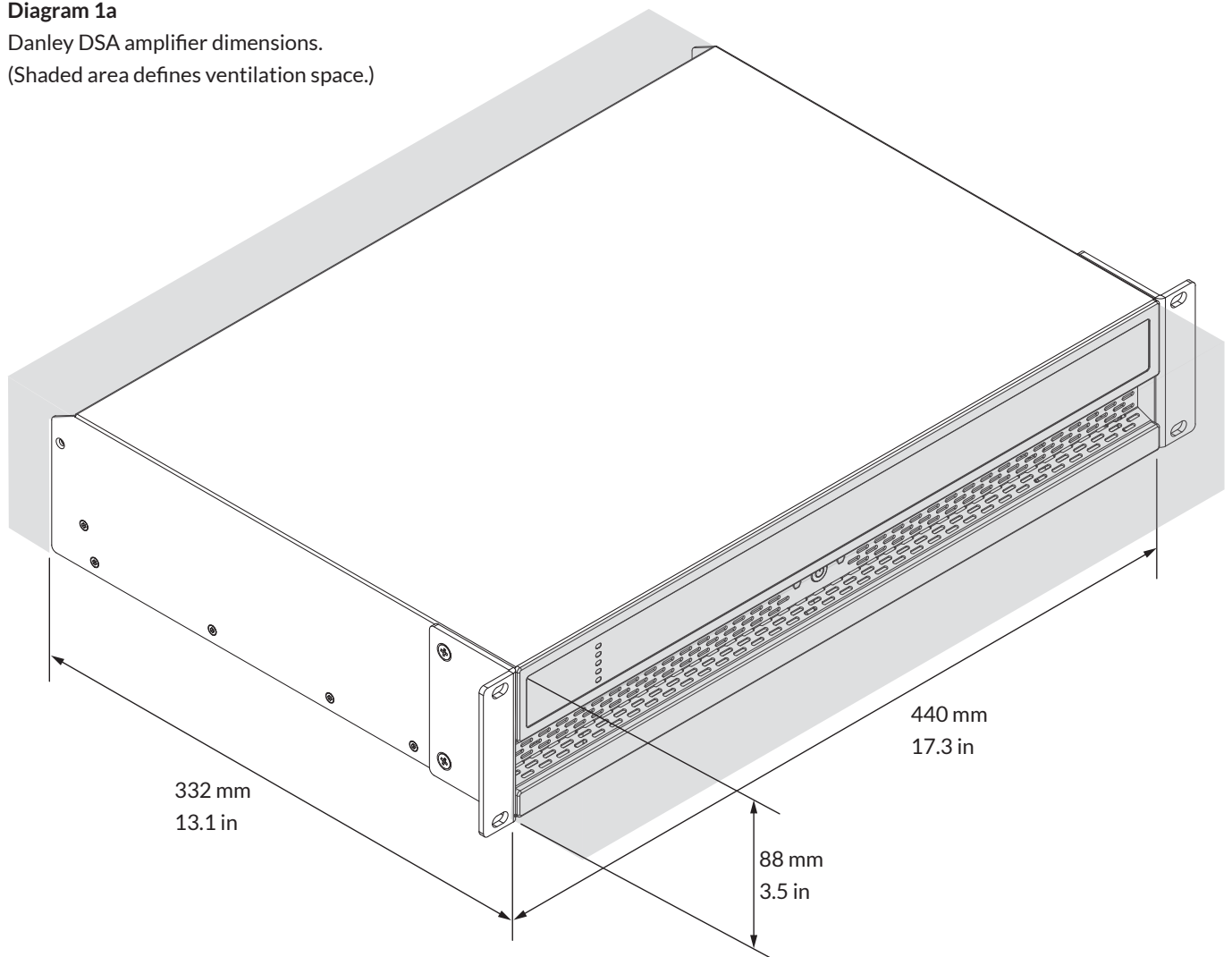
### 4.1 Amplifier Location

Danley DSA amplifiers are shipped with rack “ears” attached and are primarily intended for standard (19 inch) equipment rack installation. If not to be installed in an equipment rack, Danley DSA amplifiers can be placed free-standing on a flat surface. Adhesive rubber feet are supplied for this purpose.

It is important that any installation provides space for airflow through the ventilation apertures at the front and rear of the amplifier. This is illustrated in Diagram 1a.

#### Diagram 1a

Danley DSA amplifier dimensions.  
(Shaded area defines ventilation space.)



# Configuration

## 5. Configuration

Before making input, output and GPIO connections, an initial Danley DSA amplifier configuration should be established. It is particularly important that the amplifier output format is configured appropriately for the speakers that are to be connected.

Configuration requires that Danley DSA amplifiers are connected to mains power, switched on and connected to network services. These connections are described in the following two sections.

### 5.1 Mains Power Connection

Danley DSA amplifiers incorporate a power factor corrected power supply and can be used with mains input voltage from 100V AC to 240V AC, 50/60Hz. Use the mains cable supplied with the amplifier and connect it to a mains supply.

Press the front panel power button to switch on the amplifier. After a short delay the front panel Status indicator will illuminate green.

### 5.2 Network Services

**Danley DSA amplifiers are configured via the Control Web App interface. Before the Web App configuration menus can be accessed, Danley DSA amplifiers must be connected to the same TCP/IP network as the computer or mobile device that is to be used for configuration.**

#### 5.2.1 Wired (Ethernet) Network Connection

To connect a Danley DSA amplifier to a TCP/IP network using a wired connection (Ethernet) follow the steps below.

1. Use an Ethernet cable to connect the Danley DSA amplifier rear panel Network Control socket to a free socket on a network router or switch, or directly to an Ethernet equipped laptop or desktop computer.
2. Connect the Danley DSA amplifier to mains power using the supplied mains cable. Wait for the front panel Network indicator to illuminate green to indicate that the amplifier has network connectivity.
3. The Danley DSA amplifier default LAN IP address is 192.168.64.100. Configure the laptop or desktop computer for a fixed IP address in the same IP range; eg. 192.168.64.10, with Subnet mask of 255.255.255.0 (or prefix 24) and set the Gateway to 192.168.64.1.
4. Open a laptop or desktop web browser and enter the address

http://192.168.64.100. The Control Web App interface will open to enable amplifier configuration as required.

*Note: Danley DSA amplifiers can be configured to use DHCP for network connection if required. However, if a Danley DSA amplifier using DHCP is power cycled, it is possible that the TCP/IP network router will assign it a different IP address, leaving its configuration page inaccessible via the previous address. If this occurs, a network scanning app can be used to identify the new IP address. DHCP and Fixed IP address option settings can be found in the Settings Tab menu described in Section 5.3.*

#### 5.2.2 Wireless (WiFi) Network Connection

To connect a Danley DSA amplifier to a TCP/IP network using a wireless connection (WiFi) follow the steps below.

1. With the Danley DSA amplifier connected to mains power, wait for the front panel WiFi indicator to illuminate green.
2. Use a mobile, laptop or desktop device to search for available WiFi networks. Connect to, Danley DSA (product serial number)' using the password, '**password**'. The amplifier serial number can be found on its rear panel.
3. Open a computer or mobile device web browser and enter the IP address: 192.168.4.1. The Control Web App interface will open to enable amplifier configuration as required.
4. Select the Web App Settings Tab followed by WiFi > WiFi Mode > Client to configure the amplifier to connect to the required WiFi network. The WiFi network name and password will be required.

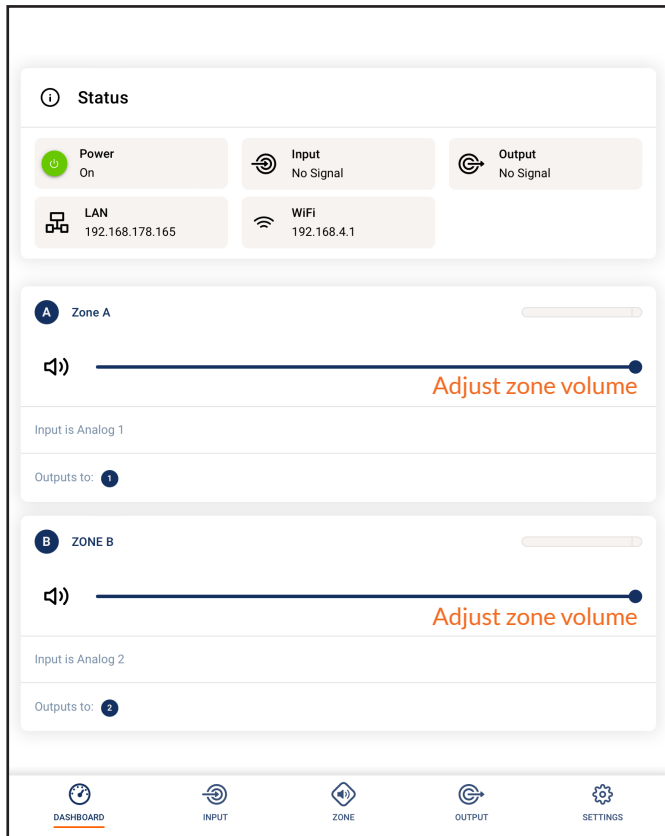
**It is strongly recommended that the Danley DSA amplifier Access Point WiFi password is changed following initial wireless connection.**

# Configuration

## 5.3 Configuration Menus

Opening a web browser that is network connected to a Danley DSA amplifier initially displays the Control Web App **Dashboard** illustrated in **Diagram 5a**. The Dashboard is the 'home' page from which all other configuration options can be accessed.

The Dashboard displays the amplifier status, output zones and the configuration menu tabs. It also enables immediate access to zone volume control. The functions available under each configuration menu tab are described in the following sections.

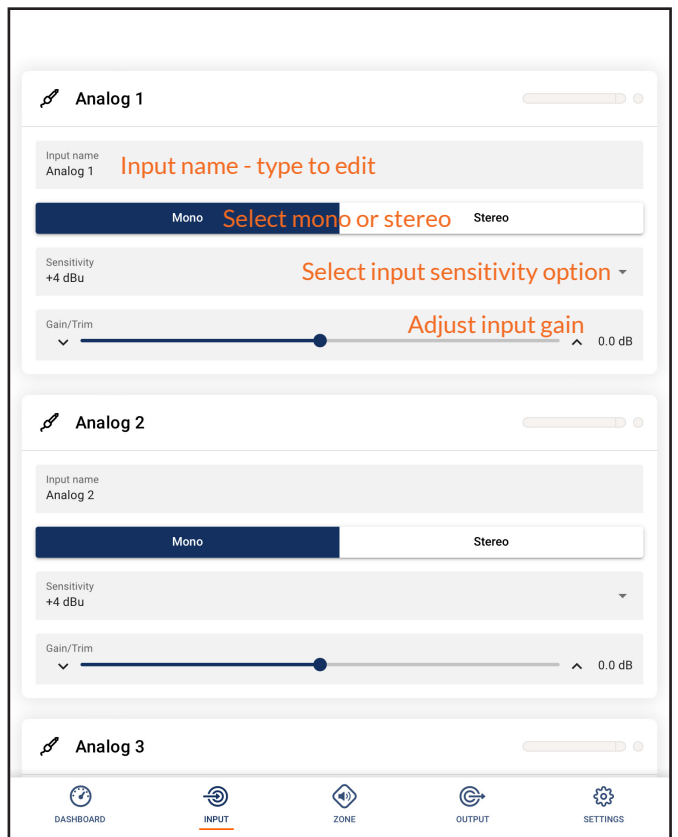


**Diagram 5a**  
Configuration Dashboard display  
(two output amplifier model shown)

## 5.3.1 Input Tab

The **Input Tab** provides **naming**, **mono/stereo selection**, **sensitivity**, and **gain trim** for each amplifier input channel. An internal pink noise source, provided for system testing and set up, can also be enabled or disabled, and adjusted for gain via the Input Tab. **Diagram 5b** illustrates the **Input Tab**.

**Diagram 5b**  
Input Tab display  
(two inputs only shown)



*Note: When adjusting input gain, the input level display should remain green. If it displays red, the input gain should be reduced.*



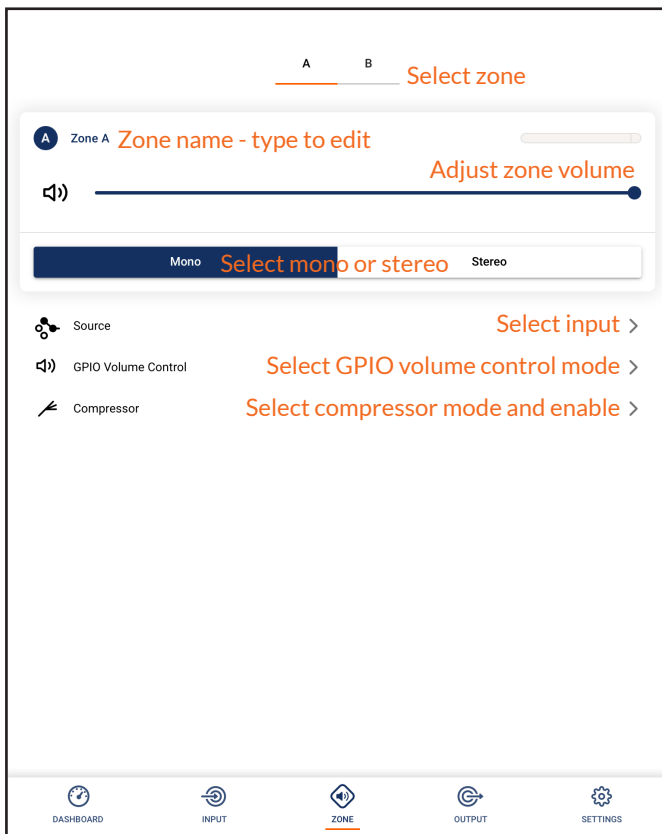
# Configuration

## 5.3.2 Zone Tab

The **Zone Tab** enables installation zones to be defined and named, and provides access to further sub-menus. Zones might be bar or restaurant areas for example, or different rooms in a home. For all Zone Tab menus, the installation zone under configuration is selected by highlighting one of the zone identifiers (A, B, C or D) at the top of the page. **Diagram 5c** illustrates the **Zone Tab**.

- The **Source** menu option enables inputs to be assigned to zones.
- The **GPIO Volume Control** option enables external volume control to be applied to individual zones. The GPIO configuration menu can be found under the **Settings Tab**.
- The **Compressor** option enables default or custom signal compression to be applied to individual installation zones.

*Note: Compression can be useful to reduce the volume difference between loud and quiet audio material. The lower the compression threshold is set, the more the difference between loud and soft will be reduced. The overall zone volume may need to be increased when compression is used. The default compression parameters are appropriate for most installations.*



**Diagram 5c**  
Zone Tab display

## 5.3.3 Output Tab

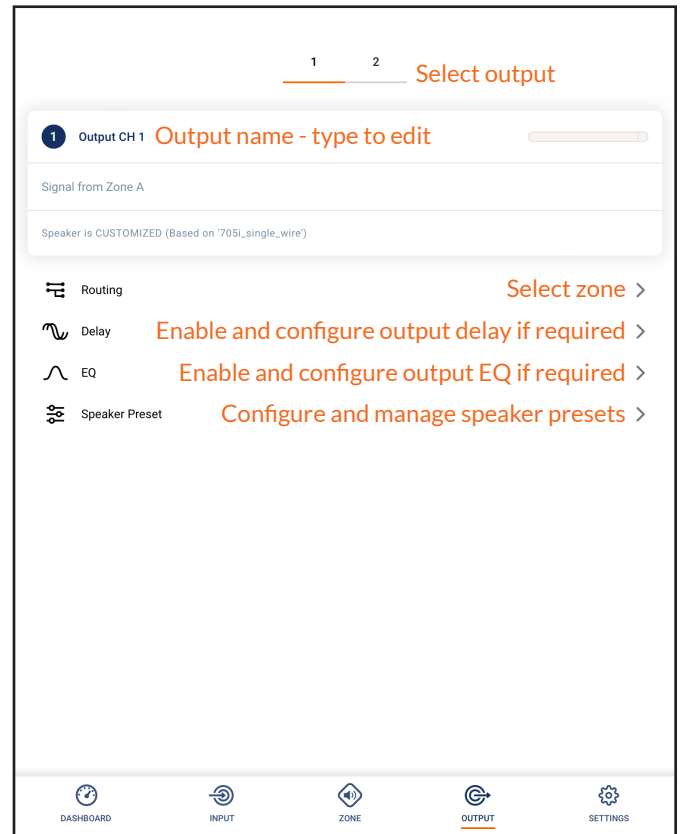
The **Output Tab** enables amplifier outputs to be named and provides access to further sub-menus. For all Output Tab menus, the amplifier output under configuration is selected by highlighting one of the output identifiers (1, 2, 3 or 4) at the top of the display. The **Output Tab** also enables **Speaker Preset** configurations to be created, exported, imported or cleared. **Diagram 5d** illustrates the **Output Tab**.

*Note: The number of individual outputs available for configuration will depend on the Danley DSA amplifier model and the input, zone and output mode configuration.*

- The **Routing** menu enables zones to be assigned to amplifier outputs.

*Note: Routing for zones specified as stereo will automatically offer three output options: left channel, right channel or summed mono. The summed mono signal can potentially be used to drive a mono subwoofer.*

- The **Delay** menu enables delay to be applied to individual amplifier outputs.
- The **Equalizer** menu enables parametric equalization to be applied to individual amplifier outputs. Equalizer settings configured for one amplifier output can be copied and applied to other outputs.



**Diagram 5d**  
Output Tab display

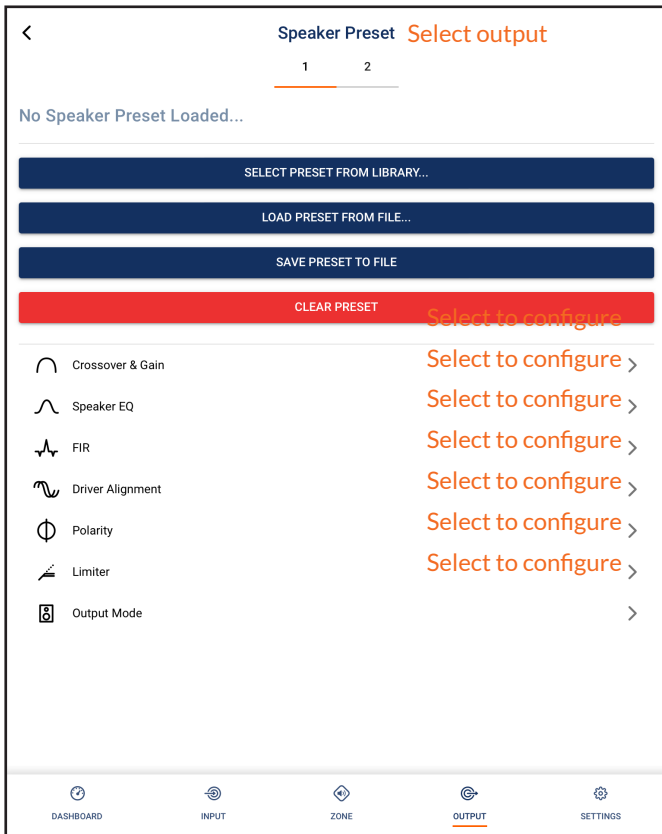
# Configuration

- The **Speaker Preset** menu enables a set of speaker parameters to be adjusted, and preset configurations to be created.
- Speaker Presets can be simply applied to the selected amplifier output or imported, chosen from a library, exported or cleared. The preset configurations can include any or all of the parameters described in Section 5.3.4 and can be locked to prevent inadvertent modification. **Diagrams 5e to 5h** illustrate the application of speaker presets.

**Speaker Preset** data provided by third parties for use with specific speakers can be imported and applied to amplifier outputs. To import speaker preset parameters follow the steps described below and illustrated in the diagrams.

1. Select either the **IMPORT PRESET FROM FILE** or **SELECT PRESET FROM LIBRARY** option from the **Speaker Preset** menu. If no import option is visible, select **CLEAR** to delete any existing speaker preset data.

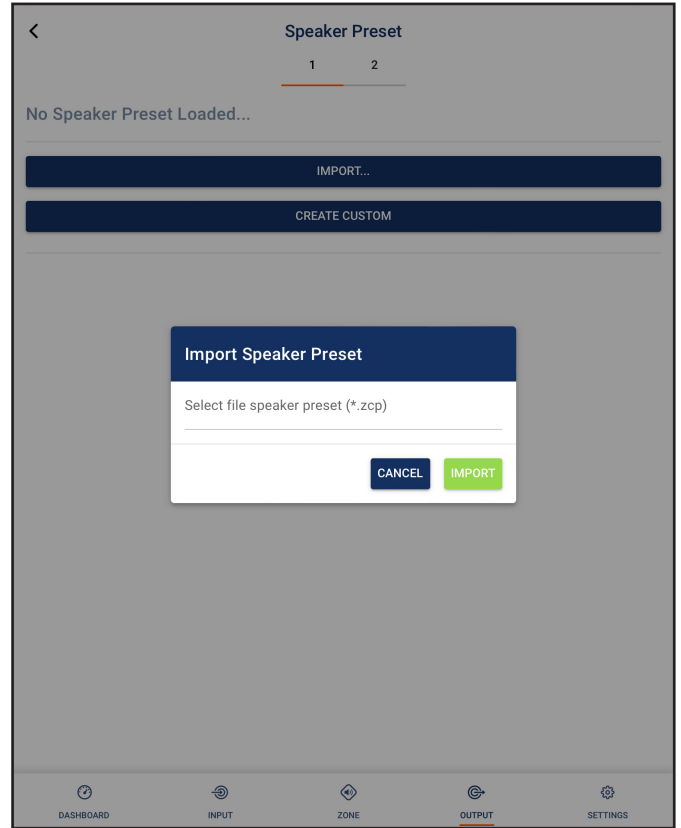
*Note: The **SELECT PRESET FROM LIBRARY** option will be unavailable if no speaker preset libraries have been created. Speaker preset library creation and management is described in Section 5.3.5.*



**Diagram 5e**  
Speaker Preset Parameters

**Diagram 5f**

Speaker Preset import file selection



2. Select the appropriate '.zcp' format speaker preset data file to import from either a Library or a computer folder. The preset data will be applied to the selected amplifier output as soon as the file import is complete.
3. If the Speaker Preset data requires modification it can be customized by selecting the **CUSTOMIZE PRESET** option.

*Note: If an imported Speaker Preset data file includes locked parameters, they will be unavailable for modification.*

## 5.3.4 Speaker Preset Menu Parameters

- The **Crossover & Gain** preset menu enables high or low-pass crossover filters and gain adjustment to be applied to individual amplifier outputs.
- The **Speaker EQ** preset menu enables parametric equalization to be applied to individual amplifier outputs.
- The **FIR** preset menu enables FIR (Finite Impulse Response) based equalization filter coefficients generated by external speaker measurement software to be imported and applied to individual amplifier outputs.

*Note: FIR coefficient files in either .csv or .txt format can be imported.*

# Configuration

Diagram 5g

Speaker Preset applied

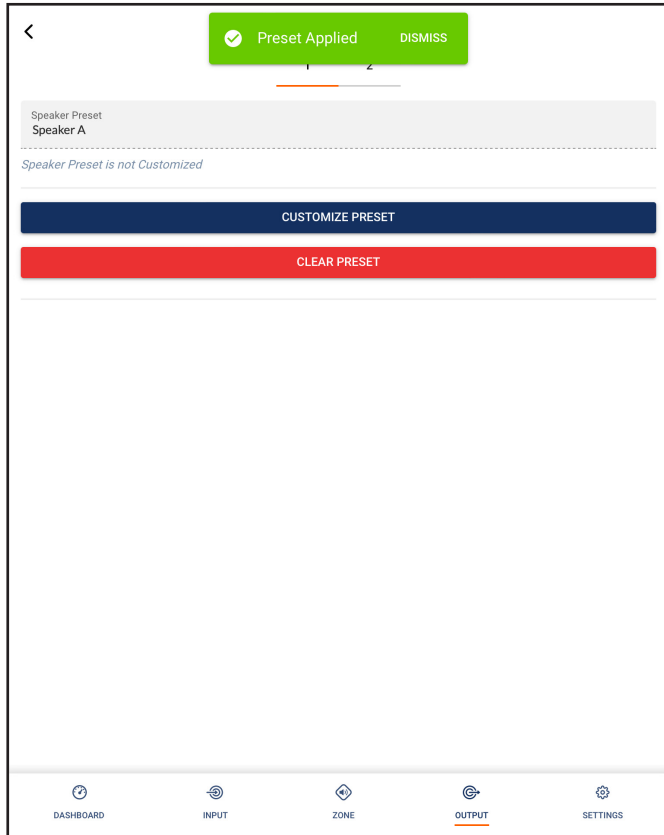
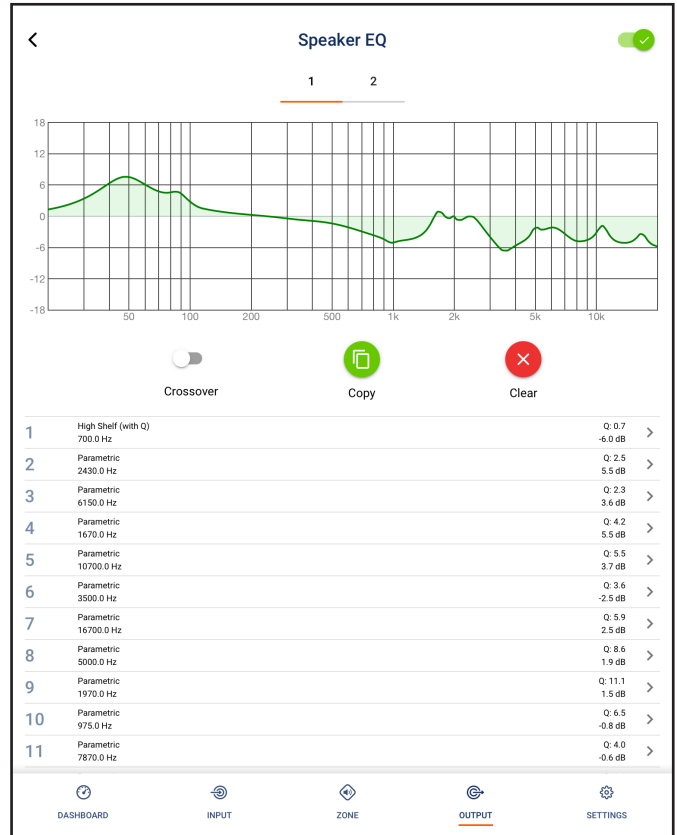


Diagram 5h

Speaker Preset parameter adjustment



- The **Driver Alignment** preset menu enables delay to be applied to individual amplifier outputs.
- The **Polarity** preset menu enables the polarity of individual amplifier outputs to be reversed.
- The **Limiter** preset menu enables signal limiting to be applied to individual amplifier outputs. Clip limiting, peak limiting and RMS limiting can be individually or collectively engaged. The Peak limiter can be set to either automatic or custom parameter values. The RMS limiter has default parameter values that can be adjusted but has no automatic option.

*Note: In automatic mode, the peak limiter parameters adjust automatically in response to Crossover & Gain high-pass filter settings.*

- The **Output Mode** preset menu enables individual amplifier outputs to be switched off or configured for Lo-Z, Hi-Z or Lo-Z BTL modes. In Hi-Z modes, a high-pass filter can also be configured and applied to the output. The number of outputs available will depend on the amplifier model, input setup and zone setup. For example, a two output amplifier will have two outputs available if Lo-Z mode is selected but only one output available if Hi-Z mode is selected.

*Note: In Lo-Z BTL (bridge-tied load) mode, two amplifier output channels are combined to create a single, double power output channel.*

*Note: Use of a high-pass filter with Hi-Z mode loudspeakers is useful to avoid the possibility of distortion caused by low frequency line transformer saturation. Begin with the default filter setting of 70Hz. If low frequency distortion is still audible, increase the frequency setting one step at a time until the distortion is no longer audible.*

# Configuration

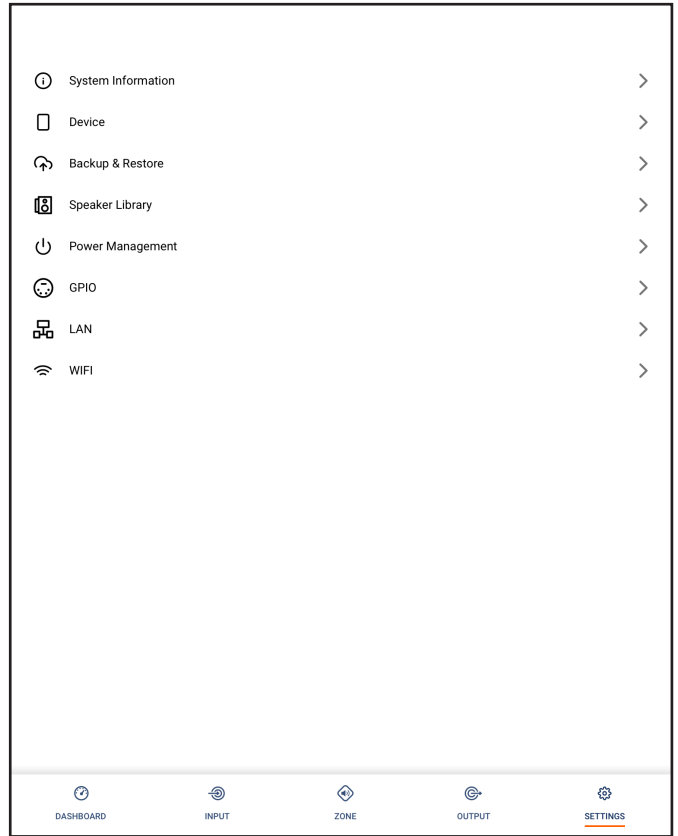
## 5.3.5 Settings Tab

The **Settings Tab** enables miscellaneous amplifier settings to be configured and installation data to be recorded. The Settings Tab provides access to further sub-menus. **Diagram 5i** illustrates the **Settings Tab**.

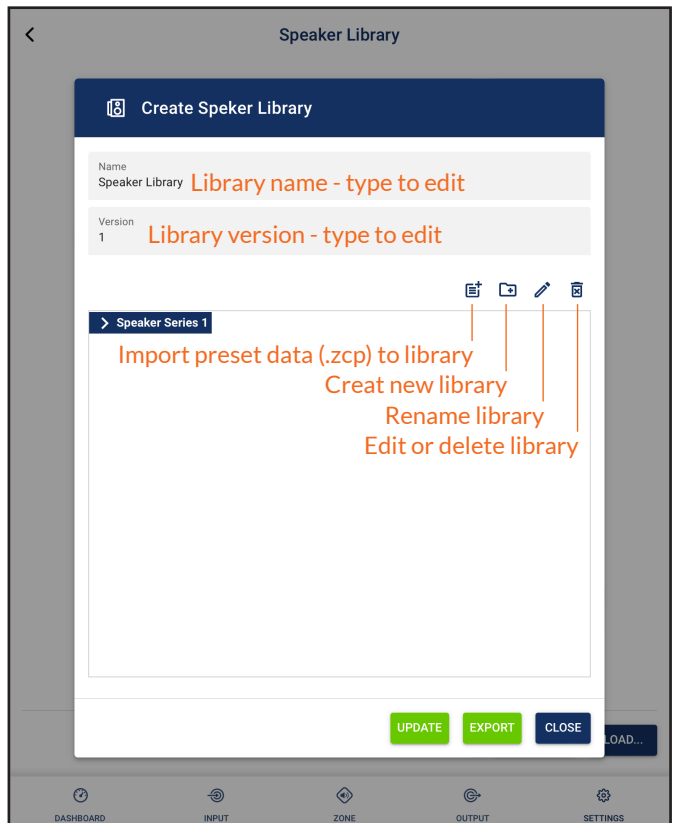
- The **System Information** menu provides text fields for the recording of installation data.
- The **Device** menu records amplifier specific information such as the model number and firmware version. A firmware update routine and identifier button can also be found under the Device menu.
- The **Backup & Restore** menu enables amplifier configuration data to be downloaded to an external archive, and enables previously saved configuration files to be uploaded and adopted by the currently connected amplifier.
- The **Speaker Library** menu enables management of speaker preset libraries. Existing libraries of speaker preset files (.zcl) can be created or imported, and existing libraries edited or fully deleted. **Diagram 5j** illustrates the creation and management of speaker preset libraries.
- The **Power Management** menu enables various automatic switch-on and standby options to be engaged. The Power Management menu also offers a timed Mute function.

*Note: The front panel power switch will override any power management settings.*

- The **GPIO** menu enables configuration of the multi-purpose GPIO interface pins.
- The **LAN** menu enables configuration and reset of the wired network options and parameters.
- The **WiFi** menu enables configuration and reset of the wireless network options and parameters.



**Diagram 5i**  
Settings Tab menu



**Diagram 5j**  
Speaker Library Creation and Management

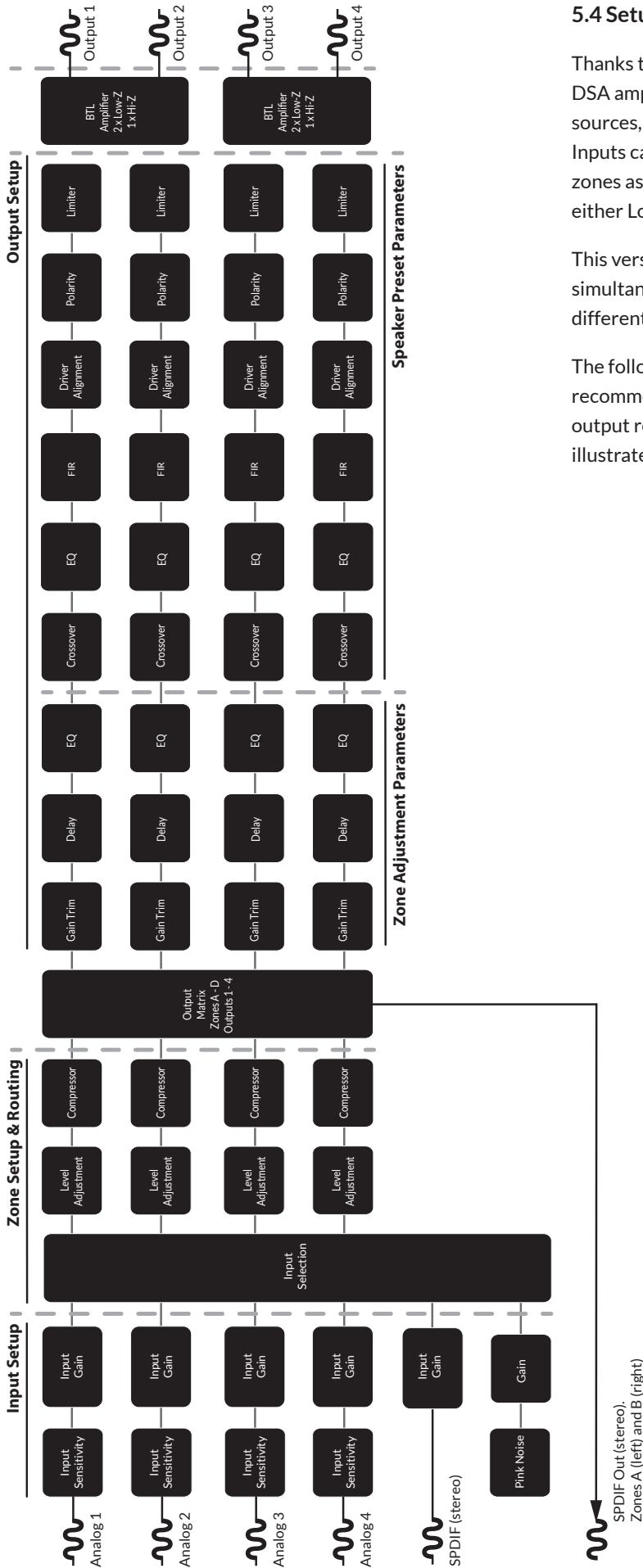
# Configuration

## 5.4 Setup and Signal Routing

Thanks to their network based configuration features, Danley DSA amplifiers offer considerable versatility in terms of sources, signal routing, installation zones and output modes. Inputs can be freely assigned to installation zones, and those zones assigned freely to the available amplifier outputs in either Lo-Z or Hi-Z modes.

This versatility enables, for example, one amplifier simultaneously to drive both Lo-Z and Hi-Z speakers, or for different inputs to be routed to different output zones.

The following paragraphs describe and illustrate the recommended procedure for configuring input, zone and output routing. A general signal flow schematic is also illustrated in **Diagram 5k**.



**Diagram 5k**  
Signal Flow Schematic  
(four output amplifier)

# Configuration

## 5.4.1 Input Setup

Open the configuration Dashboard and select the **Input Tab**. The **Input Tab** is shown in **Diagram 5b**.

- To edit default input names simply select and type in the Input Name field.
- Define a mono or stereo input by selecting the appropriate option. Defining a stereo input will reduce the total number of discrete inputs available.
- Select an input sensitivity option from the drop-down menu: +14dB, +4dB, -10dB and 'microphone' options are available. Generally, the +14dB or +4dB options are appropriate for 'professional audio' source hardware with balanced outputs, while the -10dB option is more appropriate for 'consumer audio' source hardware with unbalanced outputs. The 'microphone' option provides the significantly greater sensitivity required for microphones.

*Note: Only dynamic microphones are suitable for connection. Phantom power for condenser microphones is not provided.*

- If necessary, adjust the input gain using the slider or up/down icons. Gain adjustment is intended to be used for fine output level adjustment following initial use.

## 5.4.2 Zone Setup & Routing

Open the configuration Dashboard and select the **Zone Tab**. The **Zone Tab** is shown in **Diagram 5c**.

- Select the zone to be configured. The number of zones available and their channel format (stereo or mono) will depend on the amplifier model, input setup and output mode (Lo-Z or Hi-Z). For example, a two output amplifier can have the following zone configurations:
  - 1 x stereo Lo-Z zone
  - 2 x mono Lo-Z zones
  - 1 x mono Hi-Z zone
- A four output amplifier can have the following zones configured:
  - 2 x stereo Lo-Z zones
  - 4 x mono Lo-Z zones
  - 2 x mono Hi-Z zone
  - 1 x mono Hi-Z zone + 1 x stereo Lo-Z zone
  - 1 x mono Hi-Z zone + 2 x mono Lo-Z zones

*Note: When configured in Lo-A BTL mode of Hi-Z mode Danley DSA amplifiers operate in 'bridged' mode where the output of two channels is combined. This means that the number of output channels available in Hi-Z mode is half that available in Lo-Z mode.*

*Note: Mono signals might be mono at source, created though combining the left and right channels of a stereo signal (summed mono) or treating the left and right channels of a stereo signal independently (split mono).*

- Name zones by typing in the Zone Name field.
- Adjust the zone volume if required by using the slider.
- Define a mono or stereo zone by selecting the appropriate option. Defining a stereo zone will reduce the total number of further zones available.
- Specify an input for the zone by selecting from the drop-down menu. Selecting a stereo input for a mono zone will automatically sum the stereo channels to mono.

# Configuration

## 5.5 GPIO Setup and Connection

Danley DSA amplifiers provide a GPIO socket that enables remote control of volume, standby, mute and trigger functions. The GPIO connector pin functions are described in the **GPIO Settings** menu illustrated in **Diagram 5l**. The connection of GPIO based remote volume control and standby/mute are illustrated in **Diagram 5m** and **Diagram 5n** respectively.

*Note: The GPIO connector must not be used for any unintended purpose. Amplifier damage may result from incorrect use of GPIO.*



*Note: Shielded cable must be used when connecting standby switches and potentiometers via GPIO.*



*Note: GPIO Pin 8 has a low output impedance and is able to supply a maximum current of 10mA.*

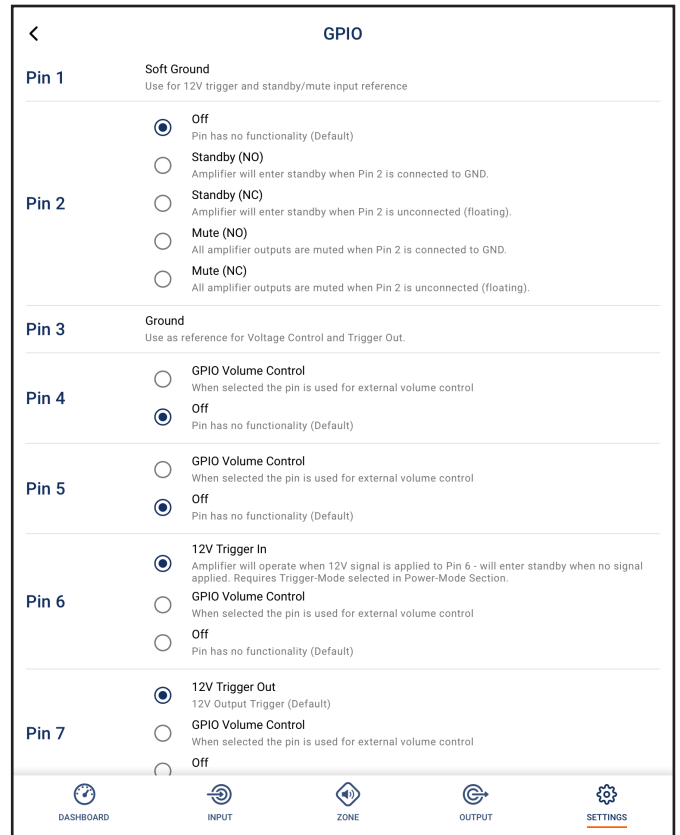


*Note: GPIO Pin 1 and Pin 3 both offer ground connections: Pin 1 is connected directly to the amplifier chassis. Pin 3 is connected to the chassis via a 220 Ohm resistor. The 'soft ground' connection of Pin 3 is potentially useful for managing ground loops that may cause audible hum.*



**Diagram 5l**

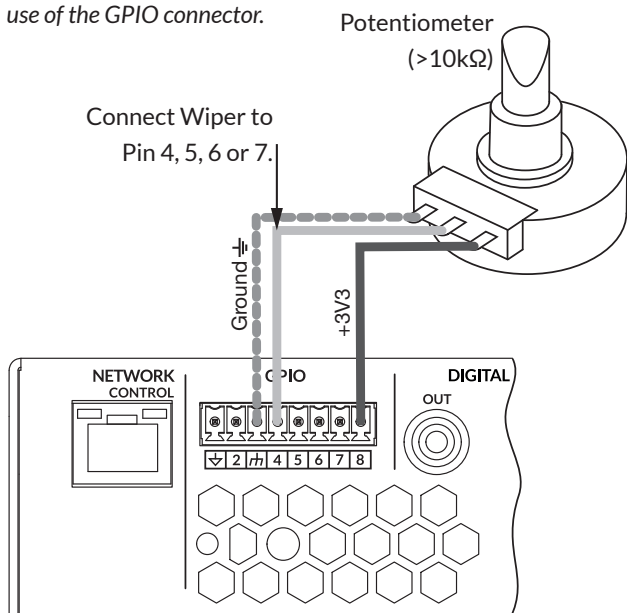
GPIO Settings Menu



**Diagram 5m**

Potentiometer connections for remote volume control via GPIO.

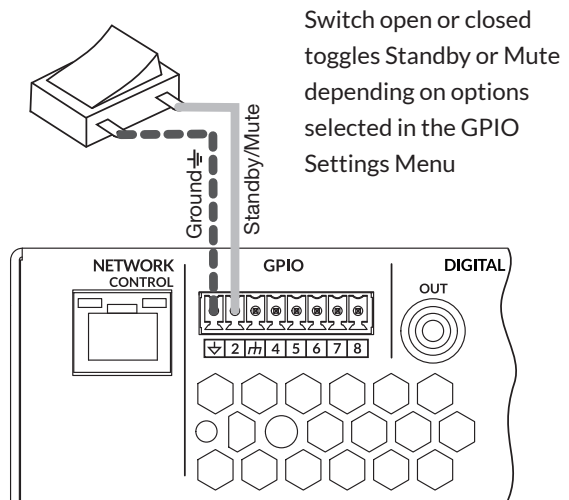
*Note: Diagram 6c illustrates use of the GPIO connector.*



**Diagram 5n**

Connections for remote standby/mute switch via GPIO.

*Note: Diagram 6c illustrates use of the GPIO connector.*



Switch open or closed toggles Standby or Mute depending on options selected in the GPIO Settings Menu

# Connections

## 6. Connections

Danley DSA amplifier rear panel connections are illustrated in Diagrams 6a.

### 6.1 Mains Power Connection

Danley DSA amplifiers incorporate a power factor corrected universal power supply and can be used with mains input voltage from 100V AC to 240V AC, 50/60Hz. Use the mains cable supplied with the amplifier.

Danley DSA amplifiers incorporate a front panel mounted power button. Press the button once to switch the amplifier on or off. **Ensure that all signal, GPIO and output connections are made before switching on the amplifier.**

### 6.2 Input Connection

All Danley DSA amplifier models provide four balanced or unbalanced analog audio inputs and a stereo S/PDIF digital audio input. Any input channel can be routed to any output channel. Input routing options can be configured via the Control Web App **Input Tab**. See **Section 5** of this manual.

#### Analog Inputs

Danley DSA analog inputs are of line level format with a default input sensitivity of +4dBu (full output voltage swing/sensitivity) in all output modes. Depending on the selected sensitivity, the inputs can handle up to +24dBu without clipping. Input sensitivity options can be set via the Control Web App **Input Tab**. See **Section 5** of this manual.

Balanced input connections to the amplifiers are made via male 'Euro Block' connectors. Connecting cables to the supplied female input connectors is illustrated in **Diagram 6b**.

Unbalanced input connections to the amplifiers are made via RCA phono sockets connected in parallel with the balanced inputs.

#### Digital Inputs

Danley DSA S/PDIF stereo digital audio input connections are made via a single RCA Phono socket. The S/PDIF input is connected by default to amplifier installation Zones A (left) and B (right).

#### Digital Outputs

Danley DSA S/PDIF stereo digital audio output connections are made via a single RCA Phono socket. The S/PDIF output signal by default reflects the input to amplifier installation Zones A and B and is intended to be used for daisy-chaining Danley DSA amplifiers.

*Note: 75Ω RCA Phono cables specifically intended for digital audio should always be used for S/PDIF connections. Standard Phono cables can be used but may not result in optimal performance.*

*Note: The S/PDIF output level is by default set at -10dB to reduce the possibility of downstream input clipping.*

### 6.3 Output Connections

Output connections from the amplifiers are achieved via male 'Euro Block' connectors. Ensure that speaker connection polarity is correct throughout the installation:

In the case of Lo-Z speaker connections, positive (+) amplifier terminals should always be connected to positive speaker terminals and negative (-) amplifier terminals always connected to negative speaker terminals.

In the case of Hi-Z speaker connections, the two speaker cable conductors should be connected between the positive (+) terminal of Output 1 and the negative terminal (-) of Output 2, and likewise for Outputs 3 and 4.

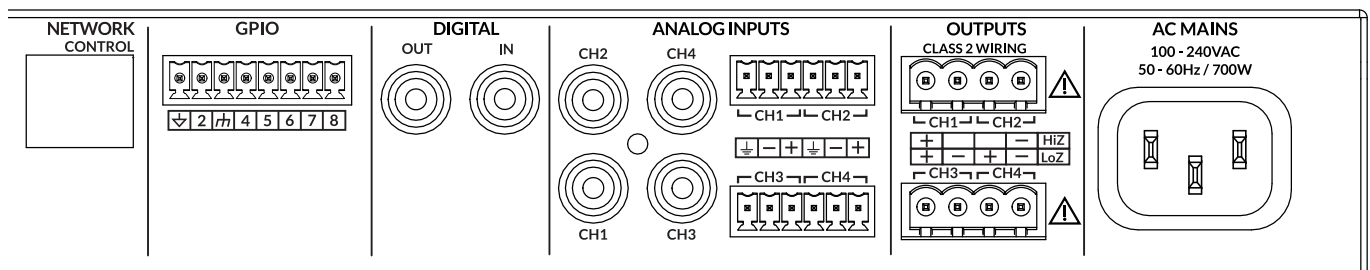
Output mode options (Lo-Z or Hi-Z) can be configured via the Control Web App **Input Tab**. See **Section 5** of this manual.

Connecting cables to the supplied female **output** connector is illustrated in **Diagram 6c**.

**Diagram 6a**

Danley DSA rear panel connections.

*Note: Two output amplifier model connection sockets differ only in the deletion of channel 3 and channel 4 output connectors.*





# Connections

## 6.4 Speaker Cable Gauge

Danley DSA speaker connection cable gauge should be chosen appropriately to reflect the type of installation. The adjacent tables specify the appropriate cable gauge and maximum cable length for less than 0.5dB cable loss in Lo-Z mode and less than 1.0dB cable loss in Hi-Z mode.

## 6.5 GPIO Connections

If any Danley DSA GPIO functionality is required, cables will need to be connected to the supplied GPIO connector. Connecting cables to the GPIO connector is illustrated in **Diagrams 6d**.

## 6.6 Network Connections

Danley DSA amplifiers are TCP/IP network connected devices that are configured via a web page based interface. Wired (Ethernet) and wireless (WiFi) connection options are available. Connecting Danley DSA amplifiers to a TCP/IP network is described in **Section 5** of this manual

**Cable Gauge Table**

Lo-Z installations, 0.5dB attenuation. 2 Ω, 4 Ω & 8 Ω loads

Cable Cross Section (mm <sup>2</sup> )	Cable Gauge (AWG)	Max Cable Length (Metres, 2 Ω load)	Max Cable Length (Metres, 4 Ω load)	Max Cable Length (Metres, 8 Ω load)
0.75	≈18	N/A	5	10
1.5	≈16	5	10	20
2.5	≈14	8	17	35
4.0	≈12	14	28	55

**Cable Gauge Table**

70V Hi-Z installations, 1.0dB attenuation

20 speakers evenly distributed

Cable Cross Section (mm <sup>2</sup> )	Cable Gauge (AWG)	Max Cable Length (Metres), (1000 W/channel)	Max Cable Length (Metres), (1200 W/channel)
0.75	≈18	25	20
1.5	≈16	50	40
2.0	≈14	80	60
3.5	≈12	125	100

**Cable Gauge Table**

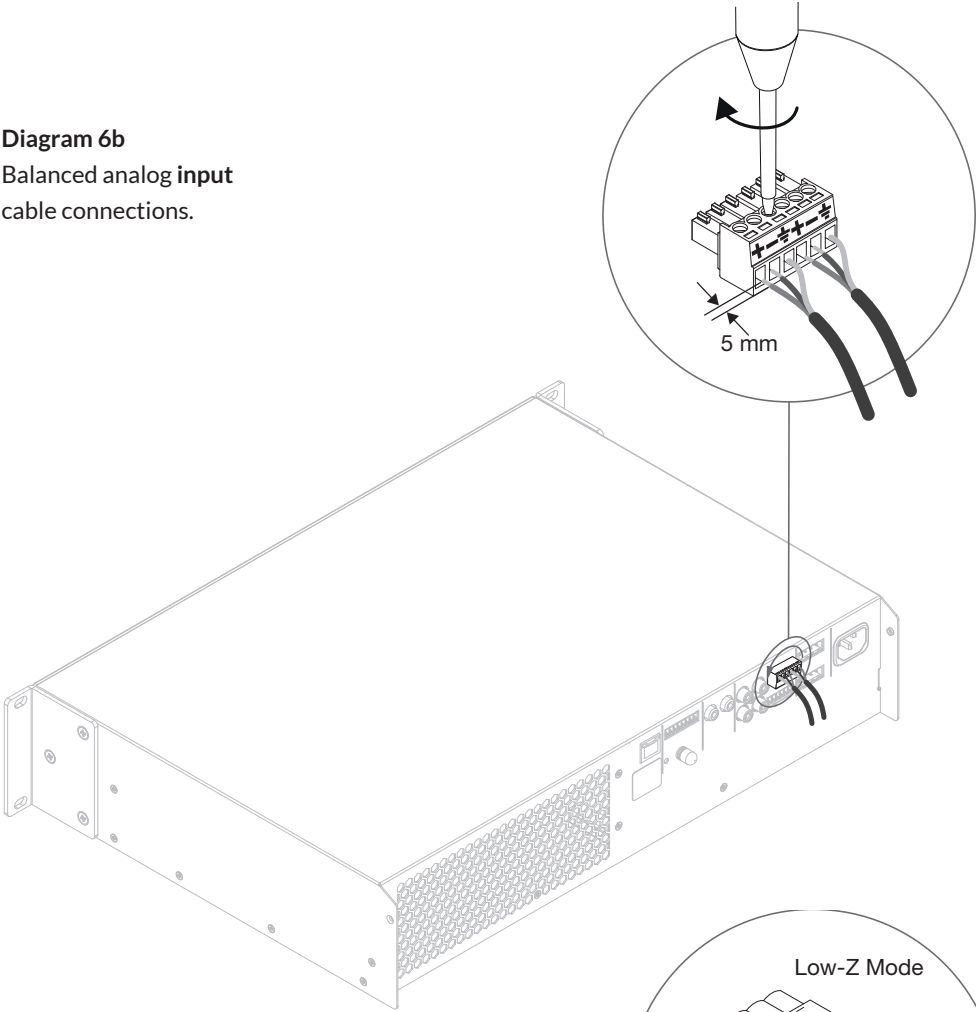
100V Hi-Z installations, 1.0dB attenuation

20 speakers evenly distributed

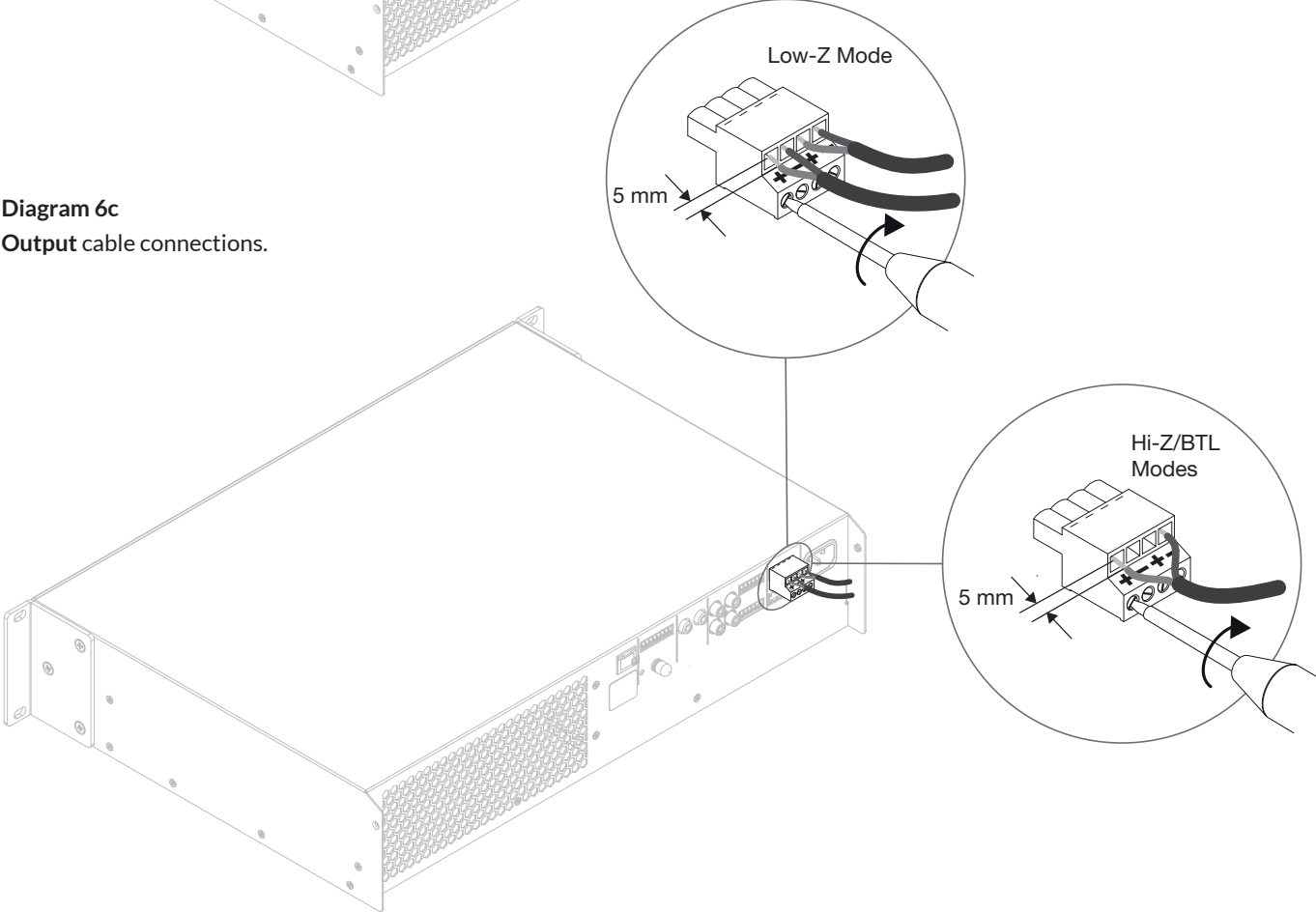
Cable Cross Section (mm <sup>2</sup> )	Cable Gauge (AWG)	Max Cable Length (Metres), (1000 W/channel)	Max Cable Length (Metres), (1500 W/channel)
0.75	≈18	50	30
1.5	≈16	100	60
2.0	≈14	160	100
3.5	≈12	250	160

# Connections

**Diagram 6b**  
Balanced analog input  
cable connections.

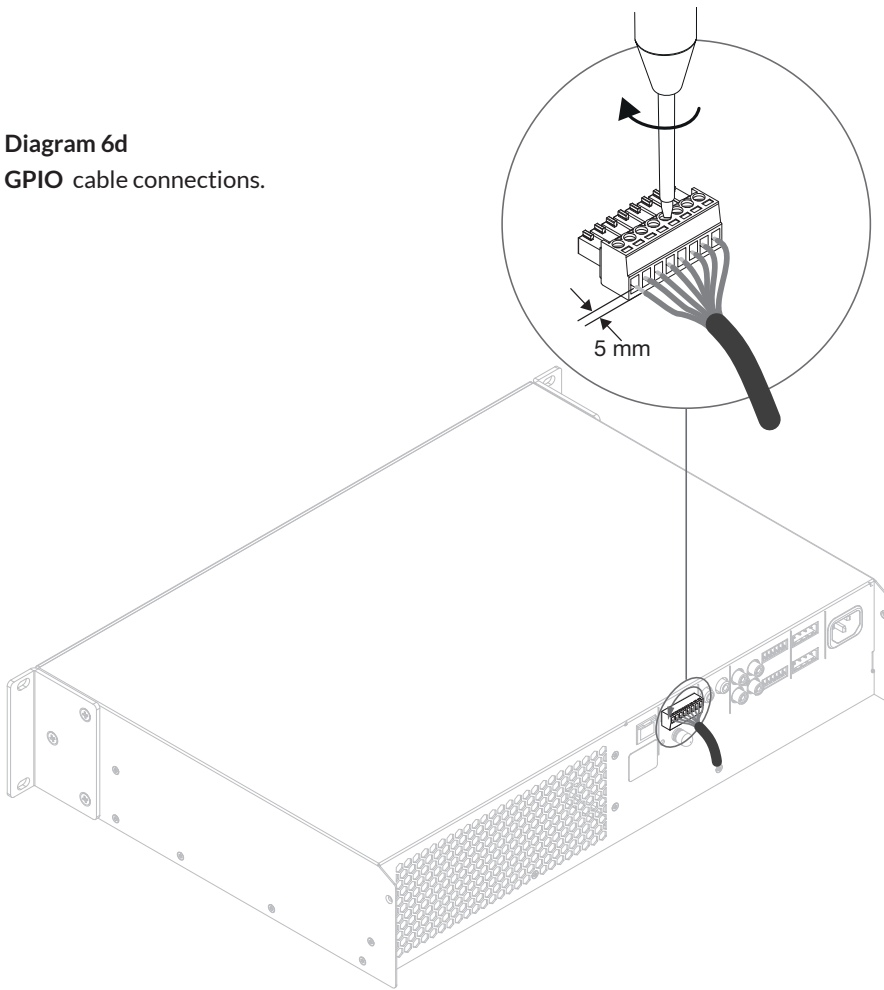


**Diagram 6c**  
Output cable connections.



# Connections

Diagram 6d  
GPIO cable connections.



The exclamation point printed next to the output terminals of the amplifiers is, in addition to the CLASS 2 WIRING text, intended to alert users to the risk of hazardous voltages. Output connectors that could pose a risk are marked with the exclamation point. Do not touch the output terminals while the amplifier is switched on. Make all connections with the amplifier switched off.

# Operation

## 7. Operation

Once all connections have been made and configuration options selected, Danley DSA amplifiers are ready for use. If an input signal above -60dB is present on any input, the front panel Input and Standby indicators will illuminate green to indicate normal amplifier operation. Audio will be heard from any connected speakers.

*Note: Danley DSA amplifiers will by default not wake from Standby Mode unless an input signal is present, a network 'ON' command is received, or an external standby switch (or 12V trigger) is operated. Standby behaviour can be configured via the Power Management menu of the Control Web App Settings Tab.*

Amplifier outputs will mute if no input signal is present for 5 minutes, and the amplifier will switch automatically to Standby Mode if no signal is present on any input for more than 15 minutes. Alternative standby and mute delay times can be selected via the **Settings Tab**. Amplifier cooling fan speed is temperature controlled. The fan will switch off when the amplifier enters standby mode.

### 7.1 Front Panel Indicators

Danley DSA amplifier front panel indicators illuminate to indicate the following operational states:

- Status:** Off – Mains power disconnected.  
Green – Amplifier operational.  
Pulse Green – Standby Mode.  
Amber – GPIO triggered Standby Mode
- Input:** Off – No input signal present.  
Green – Signal present on one or more inputs.  
Amber – Signal limiting/clipping on one or more inputs.
- Output:** Off – No output signal present.  
Green – Signal present on one or more outputs.  
Amber – Signal limiting/clipping on one or more outputs.  
Red – One or more channel pair is in overload/protection mode.
- Network:** Off – No Ethernet network detected.  
Green – Ethernet network detected.
- WiFi:** Off – WiFi disabled.  
Green – WiFi enabled.

### 7.2 Default Reset

Danley DSA amplifiers can be returned to their default settings via either the Control Web App **Settings Tab** or through the front panel power button.

To reset the amplifier using the front panel power button, follow the steps below:

- Disconnect the amplifier from mains power.
- Press and hold the front panel power button while simultaneously reconnecting mains power.
- Continue to hold the front panel power button for 3 to 5 seconds as the amplifier restarts.

The amplifier will restart with all settings at their default state. Any previously configured settings will be deleted.

# Specifications

Model	DSA500X4	DSA750X4
Channels	4 x Lo-Z/2 x Hi-Z	4 x Lo-Z/2 x Hi-Z
Output Power @ 2Ω	4 x 500 W (SE)	4 x 750 W (SE)
Output Power @ 4Ω	4 x 500 W (SE) 2 x 1000 W (BTL)	4 x 750 W (SE) 2 x 1500 W (BTL)
Output Power @ 8Ω	4 x 250 W (SE) 2 x 1000 W (BTL)	4 x 400 W (SE) 2 x 1500 W (BTL)
Output Power @ 70V	2 x 1000 W (BTL)	2 x 1200 W (BTL)
Output Power @ 100V	2 x 1000 W (BTL)	2 x 1500 W (BTL)
Total System Power	2000 W	3000 W
Power Consumption	700 W	700 W
Output Voltage	65 Vp / 130 Vpp (SE unloaded) 130 Vp / 260 Vpp (BTL unloaded)	80 Vp / 160 Vpp (SE unloaded) 160 Vp / 320 Vpp (BTL unloaded)
Weight	7.4 kg	7.4 kg

Dimensions	88 x 440 x 332 mm (3.5 x 17.3 x 13.1 in)
Output Circuitry	UMAC™ Class D - full bandwidth PWM modulator with ultra-low distortion
Signal To Noise-Ratio	>108 dB (A-weighted, 20 Hz-20 kHz, 8 Ω load)
THD+N (typical)	< 0.05 % (20 Hz-20 kHz, 8 Ω load, 3 dB below rated power)
Frequency Response	20 Hz-20 kHz (+0/-0.5 dB (8 Ω load, 3 dB below rated power)
Protection Circuits	Short circuit -, DC -, Undervoltage -, Temperature - and Overload protection
Power Supply	UREC™ universal mains switch mode power supply with Power Factor Correction (PFC) and standby converter
Operating temperature	0-40° C
Operating Voltage/ Frequency	Universal Mains, 100 V-240 V, 50 Hz-60 Hz
Standby Consumption	<0.5 W
Accessories	2x rack ears, 4 x adhesive feet
Power Ratings	1 % THD @ 120 Vac and 230 Vac

\*SE - conventional, single ended output mode

\*\*BTL - bridge-tied load output mode